

Built-in operating theatres

AKCmed

Built-in operating

AKC konstrukce



Operating theatres for the third millennium

Built-in operating theatres

AKCmed - ideal solution for:

- building of new operating theatres and their backgrounds
- reconstruction of existing spaces

AKCmed advantages:

- flexibility for future
- resistant surface
- modern solution
- easy maintenance
- fully certified system
- worldwide experience
- conformity with EU standards

AKCmed - system composition:

- supporting structure made of galvanised steel
- facing panels made of stainless steel according to the standard DIN 1.4301 (AISI 304) varnished with powdery paint and consisting of soaked plaster board
- lower ceilings made of metal panels with the integrated lighting system
- laminar field and air exhaust system

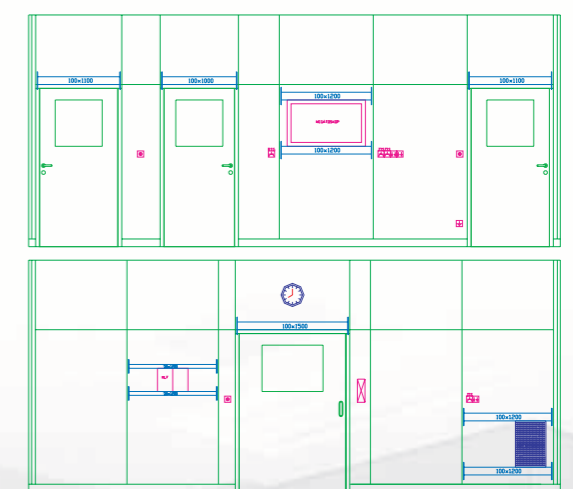
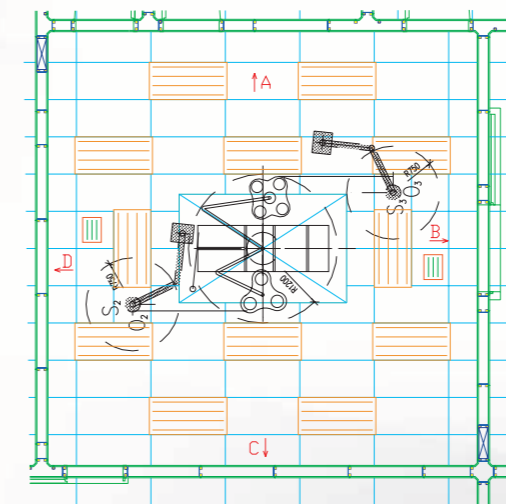
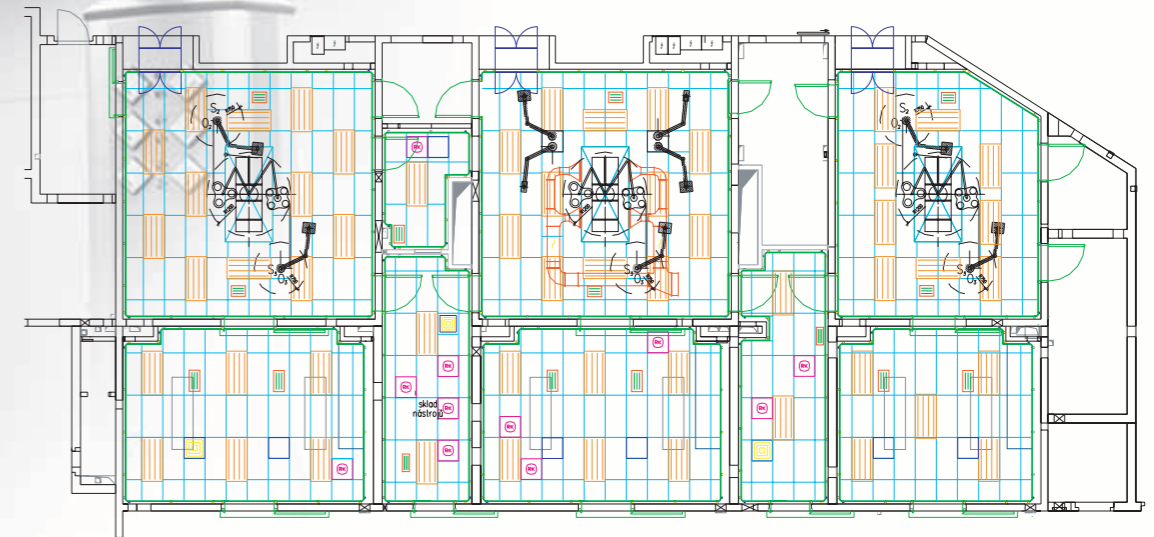

thorough project preparation - the basis of the successful implementation

for the third millennium

AKCmed[®]

Simplicity of the built-in

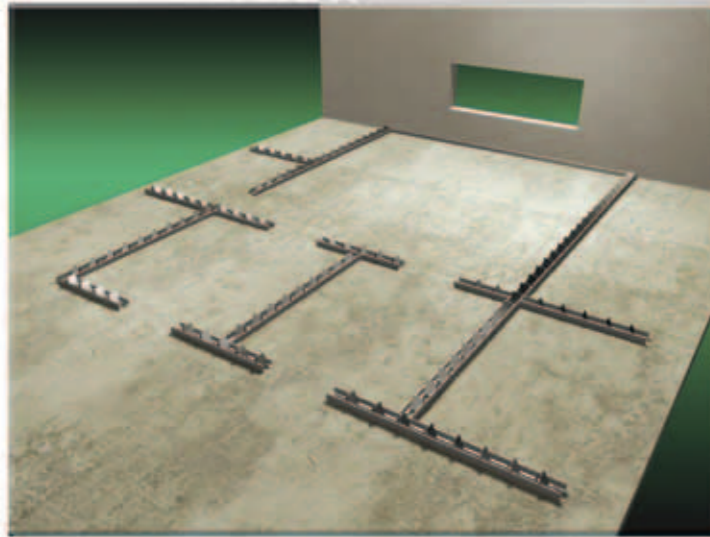

Horizontal steel structure
 • layout of new operating theatres



Assembly of power and medical gases distribution system

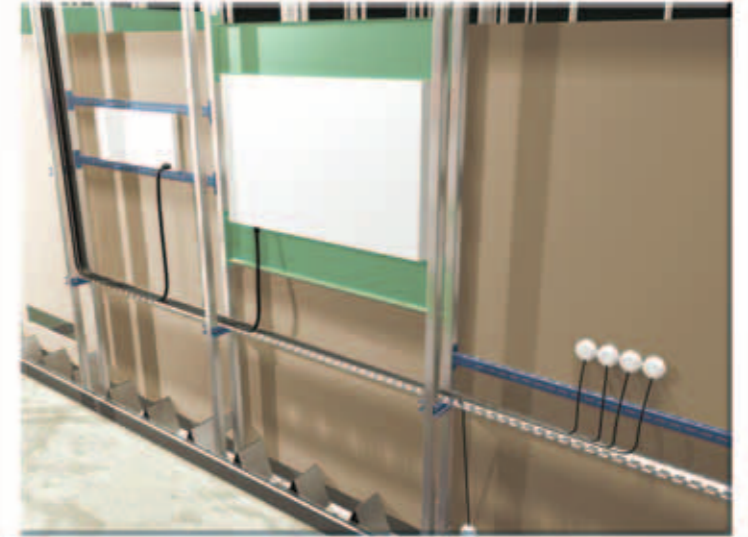

Vertical steel structure
 • operating theatres are getting the space

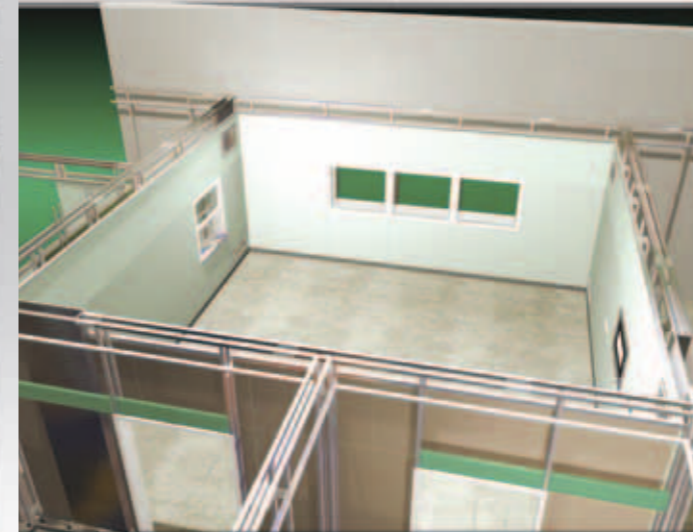
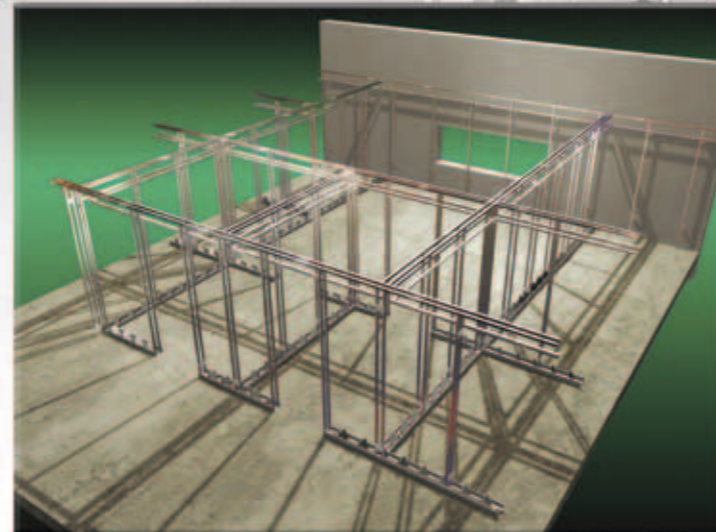

After the assembly of the stainless facing panels the operating theatre has got the hygienic surface

Assembly of auxiliary elements, windows, doorframes ...

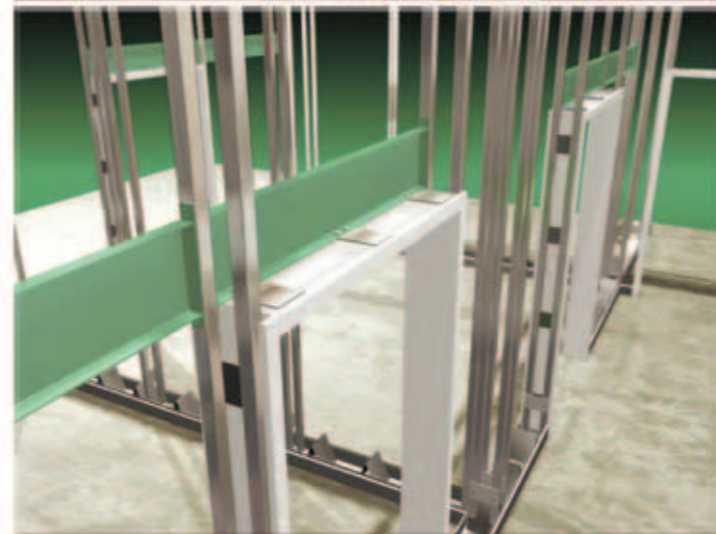

Final assembly operation
 • inserting of the silicon sealing into vertical spaces between the panels of the completed operating theatre

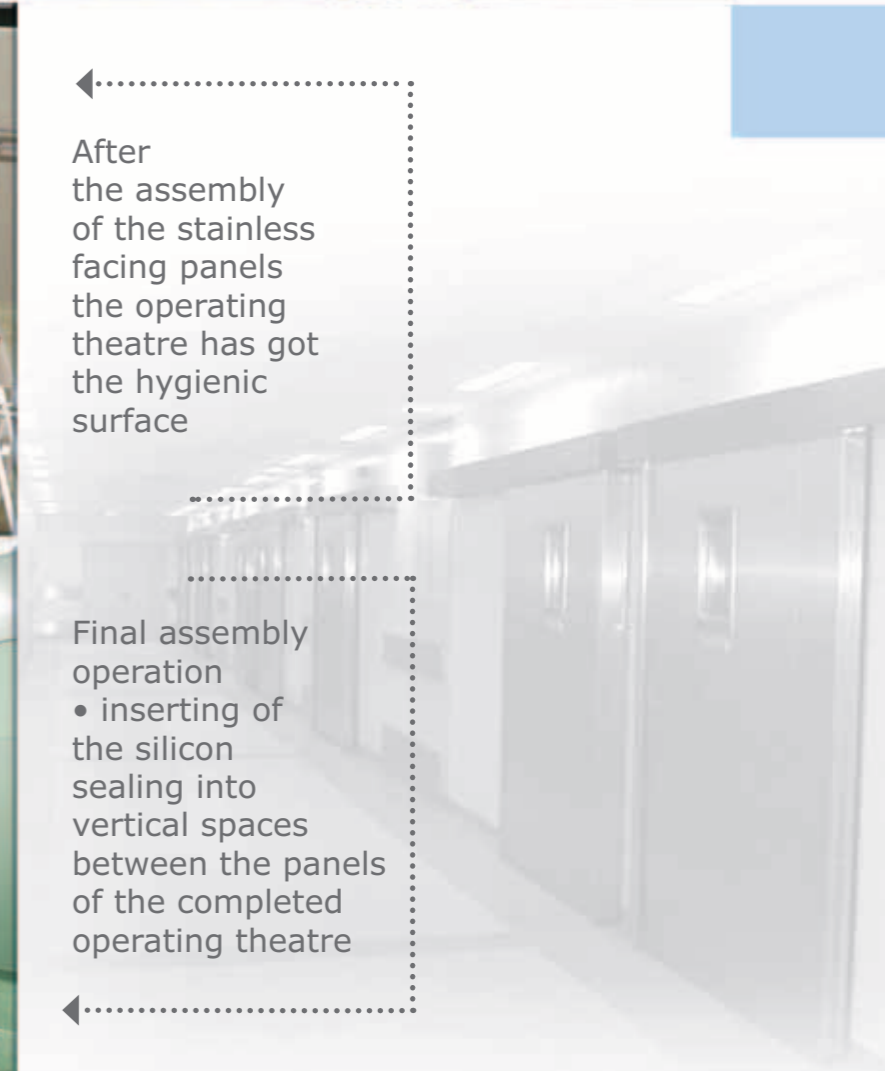

operating theatres AKCmed

meco

AKCmed®

AKCmed - operating theatres



for the third millennium



Basic colour shades:

RAL 9010
pure white



RAL 1015
ivory



RAL 1034
pastel yellow



RAL 1013
pearl white



AKC 6644
leaf green



AKC 5701
sea blue



The solution of colouring is possible in accordance with pattern books RAL, NCS and Sikkens.

Are you solving the refurbishment or construction
of the operating theatres?

Please, contact us.

We will be glad to share our experience with you.

AKC konstrukce, s.r.o.

Pivovarska 10,
756 61 Roznov pod Radhostem
tel.: +420 571 620 771-2
fax: +420 571 649 011
e-mail: info@akcmed.cz

www.akcmed.com

med

